

Funcional
Funcional
Fonctionnelle
Funcional
Funktional

Aço Inox Maciço
Solid Steel
Acier Inoxydable Massif
Acero Inox Macizo
Massives Edlsth

Desenho Estético
Stylish Design
Design Élégant
Diseño Elegante
Ästhetisches Design

Intemporal
Timeless
Intemporelle
Intemporal
Zeitlos

SISTEMAS DE CORRER
SLIDE DOOR SYSTEMS
SYSTÈMES POUR PORTES COULISSANTES
SISTEMAS PUERTAS CORREDERAS
SCHIEBETÜRSYSTEME

Sistemas de Correr

Slide Door Systems / Systèmes pour Portes Coulissantes /
Sistemas Puertas Correderas / Schiebetürsysteme

■ SCV-2 R04 Ø25

■ SCV-2 R05 Ø19

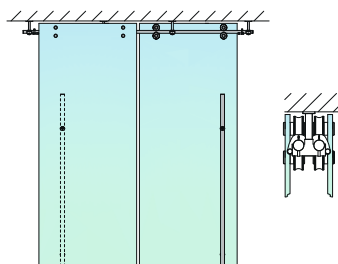
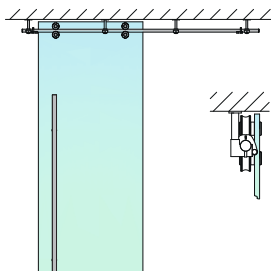
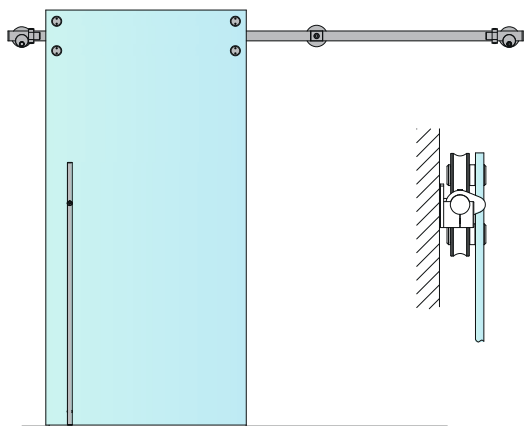
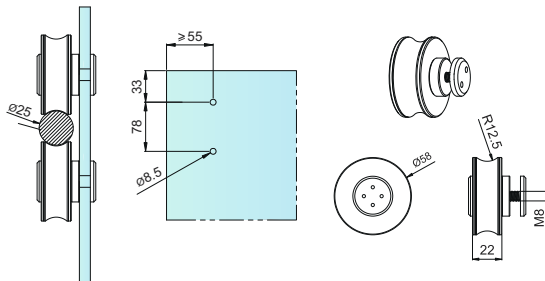
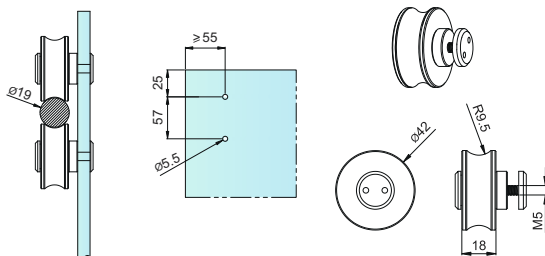

Sistemas de Correr

Slide Door Systems / Systèmes pour Portes Coulissantes /
Sistemas Puertas Correderas / Schiebetürsysteme

SCV-2 R05 Ø19

SCV-2 R04 Ø25

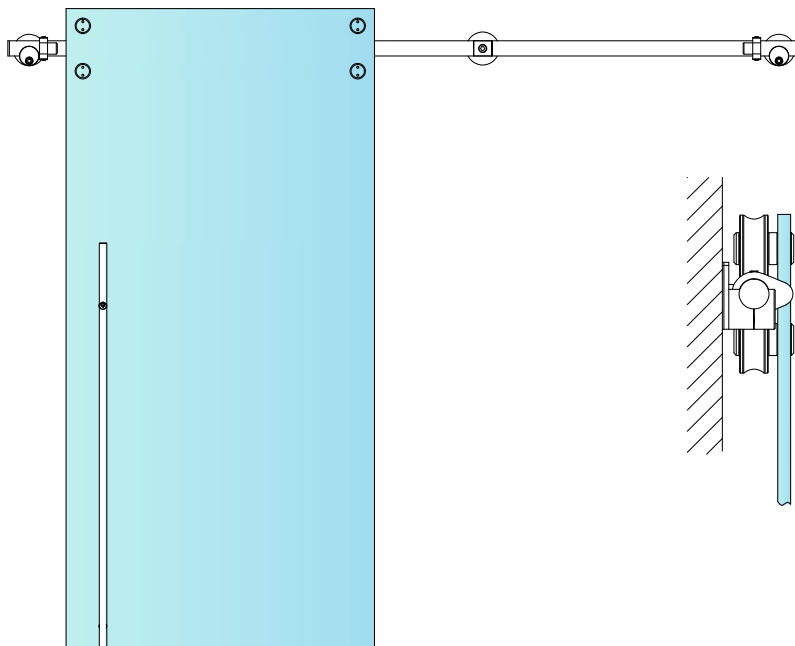
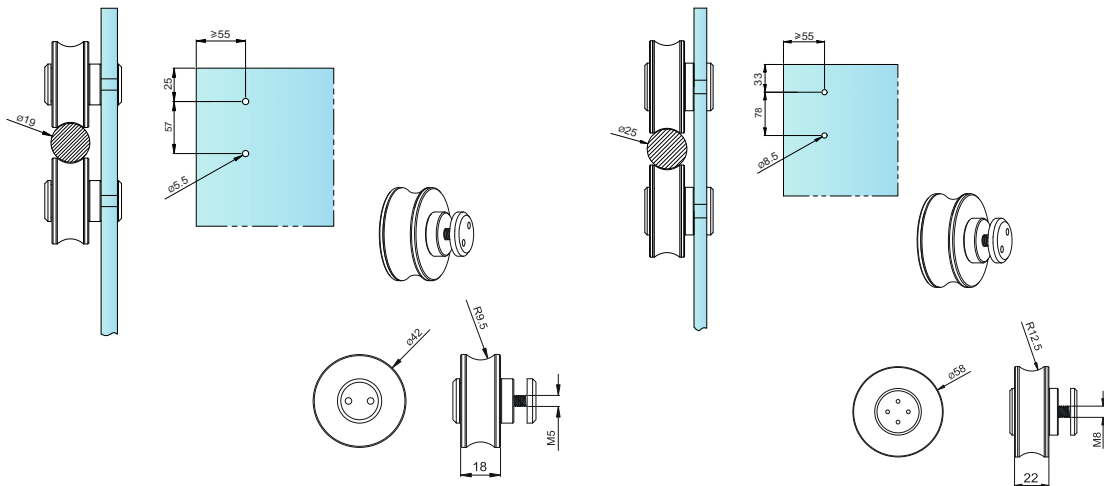

Sistemas de Correr

Slide Door Systems / Systèmes pour Portes Coulissantes /
Sistemas Puertas Correderas / Schiebetürsysteme

■ Exemplos de Aplicação | Application Examples | Exemples d'application | Ejemplos d' aplicación

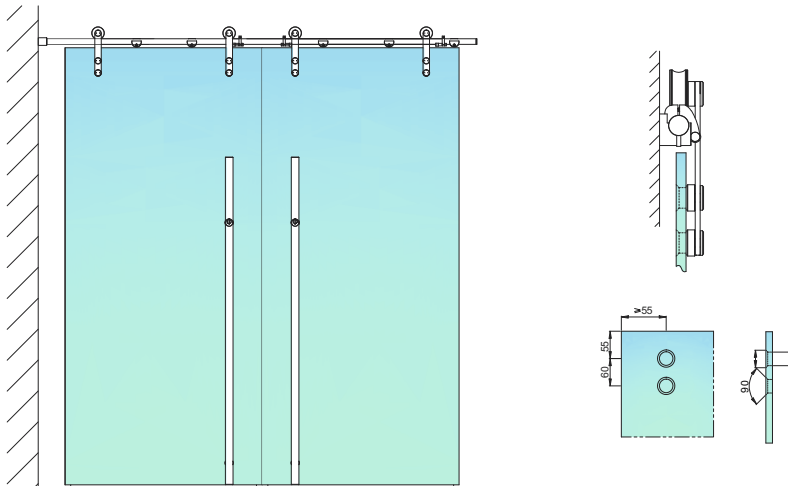

Sistemas de Correr

Slide Door Systems / Systèmes pour Portes Coulissantes /
Sistemas Puertas Correderas / Schiebetürsysteme

Exemplos de Aplicação | Application Examples | Exemples d'application | Ejemplos d' aplicación

Kit Porta de Uso Intensivo para Tubo
Para Porta de Vidro

- Kit composto por:
- 2 Carros Superiores para Tubo Porta de Vidro
 - 2 Batentes de Porta Fixação a Tubo
 - 2 Suportes Simples Laterais para Tubo
 - 2 Tampas Laterais para Tubo
 - 1 Suporte Central de Parede para Tubo
 - 1 Guia Inferior para Porta de Vidro
 - 2 Tubos Linear Roscado 1 Lado
 - 1 Chave de Aperto/Usso Medio
 - Kit Haute Resistance, /Tube
 - Pour Porte en Verre,

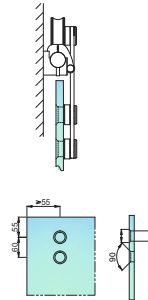
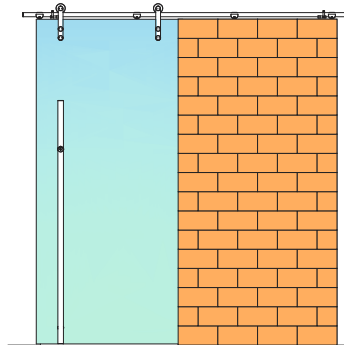

Aplicação Parede Vidro

Kit Haute Resistance
Pour Porte en Verre

- Kit Composé de:
- 2 Chariots Supérieurs /Tube Porte en Verre
 - 2 Arrêts de Porte Fixation Tube
 - 2 Connecteurs Simples Latéraux Tube
 - 2 Bouchons Latéraux Tube
 - 1 Support Murial Union Centrale Tube
 - 1 Guide Inferieur Porte en Verre
 - 2 Tubes Filetage 1 Côté
 - 1 Clé d'Ajustage
 - Kit for Heavy Duty for Tube
 - For Glass Door

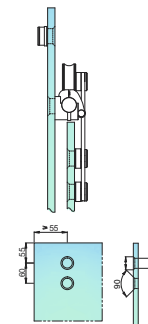
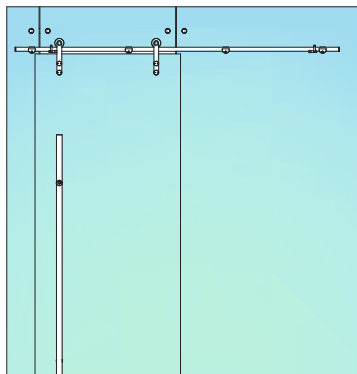

Aplicação Vidro Vidro

Kit for Heavy Duty for Tube
For Glass Door

- One set includes:
- 2 Tracks Rollers, for tube, Glass Door
 - 2 Rollers Stoppers
 - 2 Fixing Brackets to wall, Side
 - 2 Tubes End Plug
 - 1 Fixing Bracket to wall, Middle
 - 1 Glass Door Guide
 - 2 Tubes 1 meter long Screw by 1 side
 - 1 Fixing Tooling, Light duty

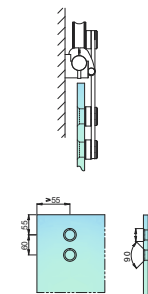
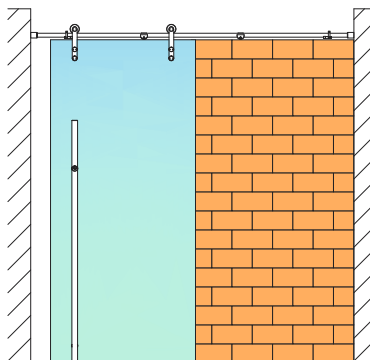

Aplicação Parede Vidro

Kit Puerta Alta Resistencia para Tubo
Para Puerta de Cristal

- Un sistema incluye:
- 2 Roldanas Superiores para para Puerta Cristal
 - 2 Topes Puerta Fijacion Tubo
 - 2 Soportes Laterales Pared
 - 2 Tapons Laterales
 - 1 Soporte Central Union
 - 1 Guia Inferior Puerta Cristal
 - 2 Tubos 1 metro Lineal Rosca 1 Lado
 - 1 Llade Ajuste

Sistemas de Correr

Slide Door Systems / Systèmes pour Portes Coulissantes /
Sistemas Puertas Correderas / Schiebetürsysteme

■ Exemplos de Aplicação | Application Examples | Exemples d'application | Ejemplos d' aplicación

Portas de Correr
Aplicação ao Tecto

Sliding Door
Roof Fixation

Porte Colissante
Fixation au Planfond

Puerta Corredera
Fijacion al Techo

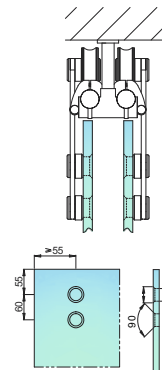
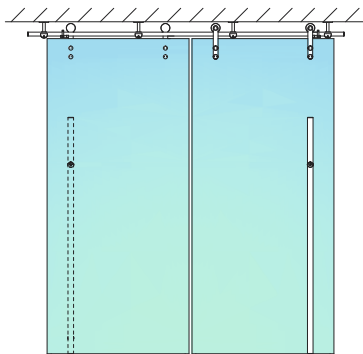

Portas de Correr
Aplicação ao Tecto

Sliding Door
Roof Fixation

Porte Colissante
Fixation au Planfond

Puerta Corredera
Fijacion al Techo

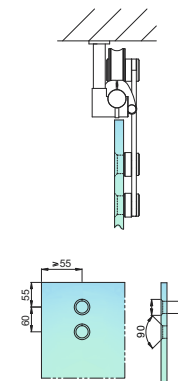
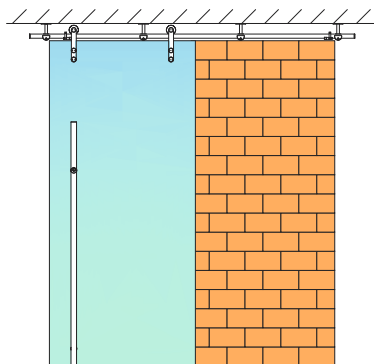

Portas de Correr
Aplicação ao Tecto

Sliding Door
Roof Fixation

Porte Colissante
Fixation au Planfond

Puerta Corredera
Fijacion al Techo

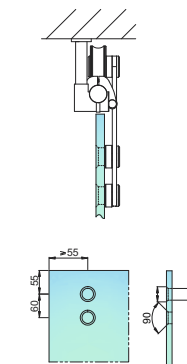
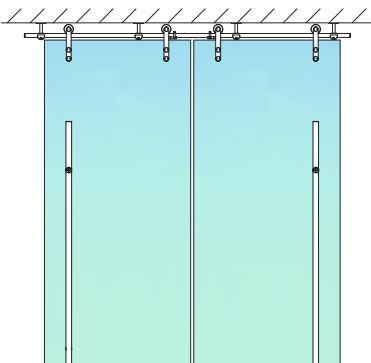

Sistemas de Correr

Slide Door Systems / Systèmes pour Portes Coulissantes /
Sistemas Puertas Correderas / Schiebetürsysteme

SCV-01

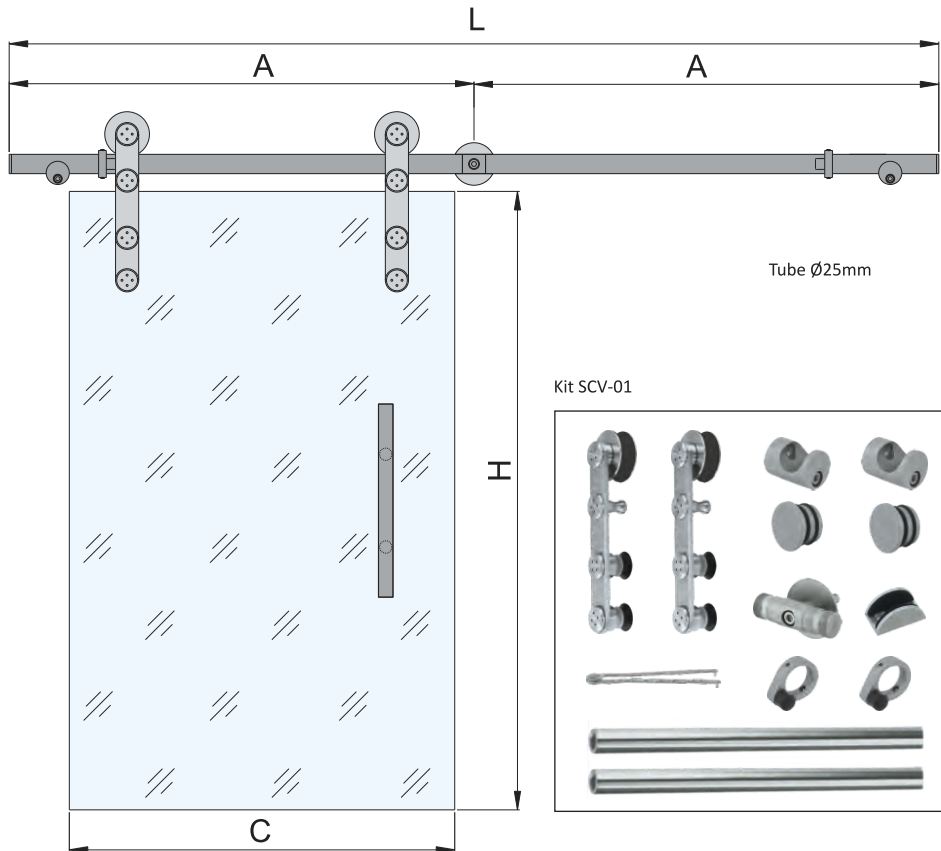

Kit Porta de Uso Intensivo para Tubo Ø25mm
Para Porta de Vidro 8-12mm, 60-100 Kgs

Kit composto por:
2 Carrros Superiores para Tubo 25mm Porta de Vidro
2 Batentes de Porta Fixação a Tubo 25mm
2 Suportes Simples Laterais para Tubo 25mm
2 Tampas Laterais para Tubo 25mm
1 Suporte Central de Parede para Tubo 25mm
1 Guia Inferior para Porta de Vidro
2 Tubos 1m Linear Roscado 1 Lado 25mm
1 Chave de Aperto/Usso Medio

Kit Haute Resistance, /Tubo Ø25mm
Pour Porte en Verre, 8-12mm, 60-100 Kgs

Kit Composé de:
2 Chariots Supérieurs /Tubo 25mm Porte en Verre
2 Arrêts de Porte Fixation Tube 25mm
2 Connecteurs Simples Latéraux Tube 25mm
2 Bouchons Latéraux Tube 25mm
1 Support mural Union Centrale Tube 25mm
1 Guide Inferieur Porte en Verre
2 Tubes de 1m Filottage 1 Côté 25mm
1 Clé d'Ajustage

Tube Ø25mm

Kit SCV-01



Kit for Heavy Duty for Tube Ø25mm
For Glass Door, 8-12mm, 60-100 Kgs

One set includes:
2 Tracks Rollers, for 25mm tube, Glass Door
2 Rollers Stoppers 25mm
2 Fixing Brackets to wall, Side 25mm
2 Tubes End Plug 25mm
1 Fixing Bracket to wall, Middle 25mm
1 Glass Door Guide
2 Tubes 1 meter long Screw by 1 side - 25mm
1 Fixing Tooling, Light duty

Kit Puerta Alta Resistencia para Tubo Ø25mm
Para Puerta de Cristal, 8-12mm, 60-100 Kgs

Un sistema incluye:
2 Roldanas Superiores para Tubo 25mm para Puerta Cristal
2 Topes Puerta Fijacion Tubo 25mm
2 Soportes Laterales Pared 25mm
2 Tapons Laterales 25mm
1 Soporte Central Union 25mm
1 Guia Inferior Puerta Cristal
2 Tubos 1 metro Lineal Rosca 1 Lado 25mm
1 Lado Ajuste

Sistemas de Correr

Slide Door Systems / Systèmes pour Portes Coulissantes /
Sistemas Puertas Correderas / Schiebetürsysteme

SCV-02

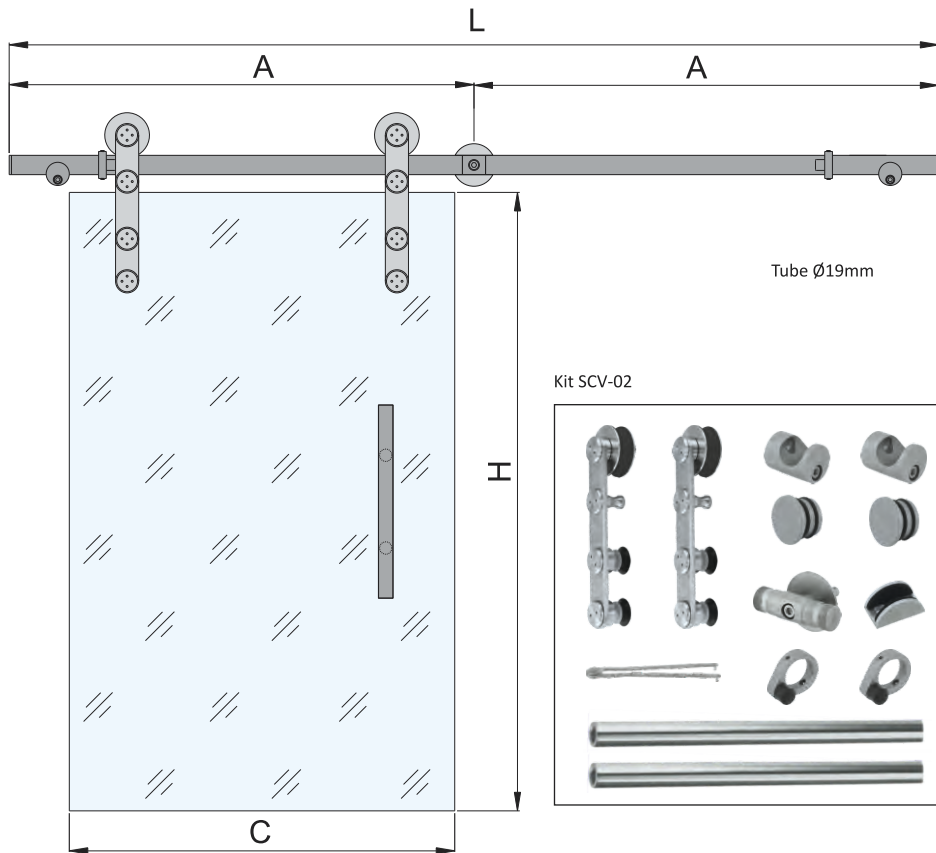

Kit Porta de Uso Intensivo para Tubo Ø19mm
Para Porta de Vidro 8-12mm, 50-90 Kgs

- Kit composto por:
- 2 Carros Superiores para Tubo 19mm Porta de Vidro
 - 2 Batentes de Porta Fixação a Tubo 19mm
 - 2 Suportes Simples Laterais para Tubo 19mm
 - 2 Tampas Laterais para Tubo 19mm
 - 1 Suporte Central de Parede para Tubo 19mm
 - 1 Guia Inferior para Porta de Vidro
 - 2 Tubos 1m Linear Roscado 1 Lado 19mm
 - 1 Chave de Aperto/Usso Medio

Kit Haute Resistance, /Tubo Ø19mm
Pour Porte en Verre, 8-12mm, 50-90 Kgs

- Kit Composé de:
- 2 Chariots Supérieurs /Tubo 19mm Porte en Verre
 - 2 Arrêts de Porte Fixation Tube 19mm
 - 2 Connecteurs Simples Latéraux Tube 19mm
 - 2 Bouchons Latéraux Tube 19mm
 - 1 Support Mural Union Centrale Tube 19mm
 - 1 Guide Inferieur Porte en Verre
 - 2 Tubes de 1m1 Filetage 1 Côté 19mm
 - 1 Clé d'Ajustage

Tube Ø19mm

Kit SCV-02



Kit for Heavy Duty for Tube Ø19mm
For Glass Door, 8-12mm, 50-90 Kgs

- One set includes:
- 2 Tracks Rollers, for 19mm tube, Glass Door
 - 2 Rollers Stoppers 19mm
 - 2 Fixing Brackets to wall, Side 19mm
 - 2 Tubes End Plug 19mm
 - 1 Fixing Bracket to wall, Middle 19mm
 - 1 Glass Door Guide
 - 2 Tubes 1 meter long Screw by 1 side - 19mm
 - 1 Fixing Tooling, Light duty

Kit Puerta Alta Resistencia para Tubo Ø19mm
Para Puerta de Cristal, 8-12mm, 50-90 Kgs

- Un sistema incluye:
- 2 Roldanas Superiores para Tubo 19mm para Puerta Cristal
 - 2 Topes Puerta Fijacion Tubo 19mm
 - 2 Soportes Laterales Pared 19mm
 - 2 Tapons Laterales 19mm
 - 1 Soporte Central Union Puerta Cristal
 - 1 Guia Inferior Puerta Cristal
 - 2 Tubos 1 metro Lineal Rosca 1 Lado 19mm
 - 1 Llave Ajuste

Sistemas de Correr

Slide Door Systems / Systèmes pour Portes Coulissantes /
Sistemas Puertas Correderas / Schiebetürsysteme

SCM-01

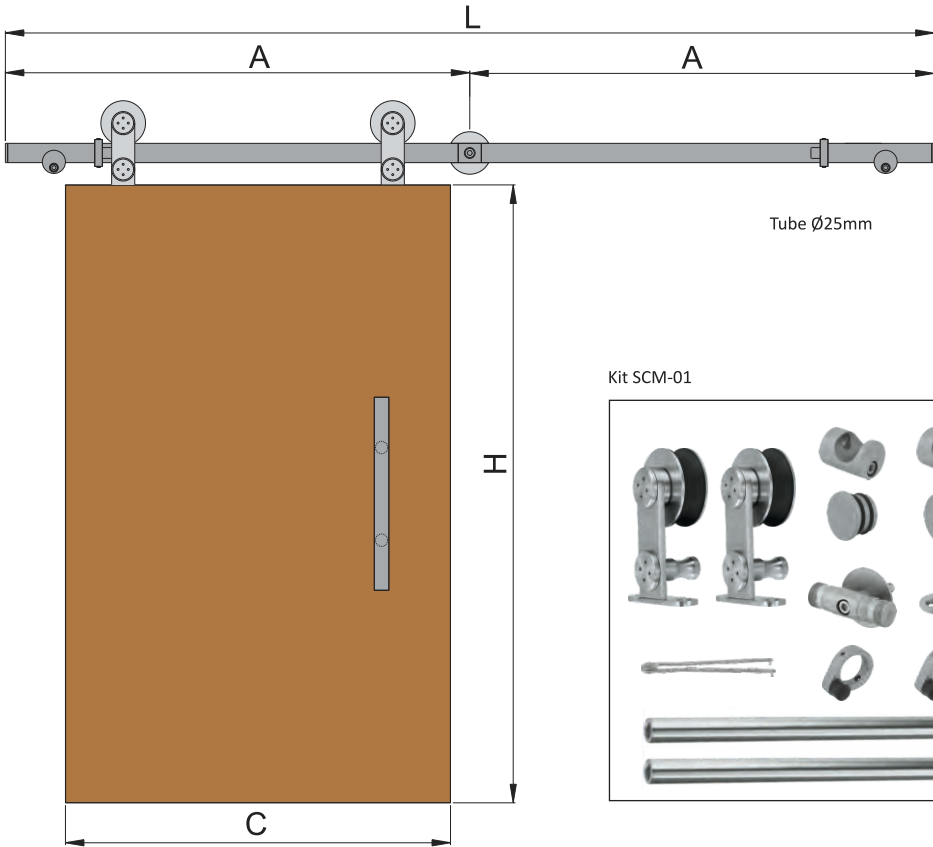

Kit Porta de Uso Intensivo para Tubo Ø25mm
Para Porta de Madeira 25-50mm, 30-60 Kgs

Kit composto por:
2 Carros Superiores para Tubo 25mm Porta de Madeira
2 Bateria de Porta Fixação a Tubo 25mm
2 Suportes Simples Laterais para Tubo 25mm
2 Tampas Laterais para Tubo 25mm
1 Suporte Central de Parede para Tubo 25mm
1 Guia Inferior para Porta de Madeira
2 Tubos 1m Linear Roscado 1 Lado 25mm
1 Chave de Aperto/Usso Medio

Kit Haute Resistance, /Tubo Ø25mm
Pour Porte en Bois, 25-50mm, 30-60 Kgs

Kit Composé de:
2 Chariots Supérieurs /Tubo 25mm Porte en Bois
2 Arrêts de Porte Fixation Tubo 25mm
2 Connecteurs Simples Latéraux Tubo 25mm
2 Bouchons Latéraux Tubo 25mm
1 Support Mural Union Centrale Tubo 25mm
1 Guide Inférieur Porte en Bois
2 Tubes de 1m Filétage 1 Côté 25mm
1 Clé d'Ajustage

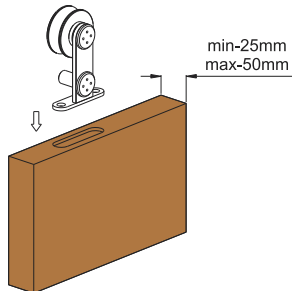

Tube Ø25mm

Kit SCM-01



Kit for Heavy Duty for Tube Ø25mm
For Wood Door, 25-50mm, 30-60 Kgs

One set includes:
2 Tracks Rollers, for 25mm tube, Wood Door
2 Rollers/Scoopers 25mm
2 Fixing Brackets to wall, Side 25mm
2 Tubes End Plug 25mm
1 Fixing Bracket to wall, Middle 25mm
1 Wood Door Guide
2 Tubes 1 meter long Screw by 1 side - 25mm
1 Fixing Tooling, Light duty

Kit Puerta Alta Resistencia para Tubo Ø25mm
Para Puerta de Madera, 25-50mm, 30-60 Kgs

Un sistema incluye:
2 Roldanas Superiores para Tubo 25mm para Puerta Madera
2 Topes Puerta Fijacion Tubo 25mm
2 Soportes Laterales Pared 25mm
2 Tapons Laterales 25mm
1 Soporte Central Union 25mm
1 Guia Inferior Puerta Madera
2 Tubos 1 metro Lineal Rosca 1 Lado 25mm
1 Llave Ajuste

Sistemas de Correr

Slide Door Systems / Systèmes pour Portes Coulissantes /
Sistemas Puertas Correderas / Schiebetürsysteme

■ Exemplos de Aplicação | Application Examples | Exemples d'application | Ejemplos d'aplicación

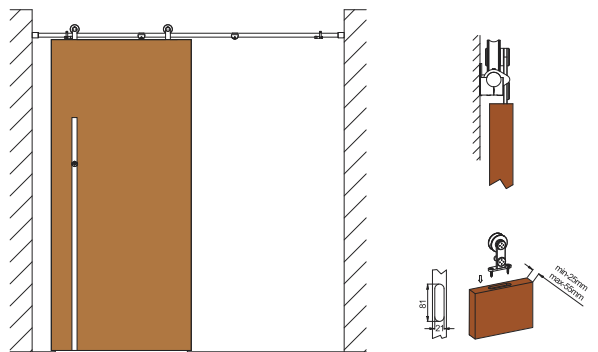
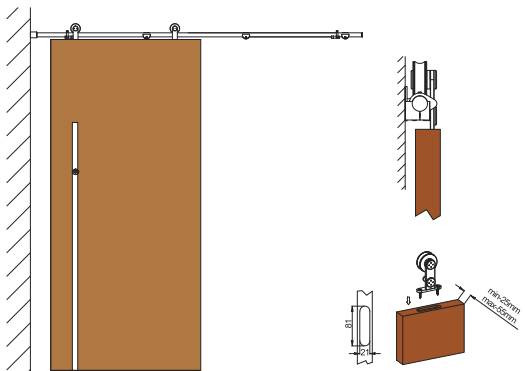
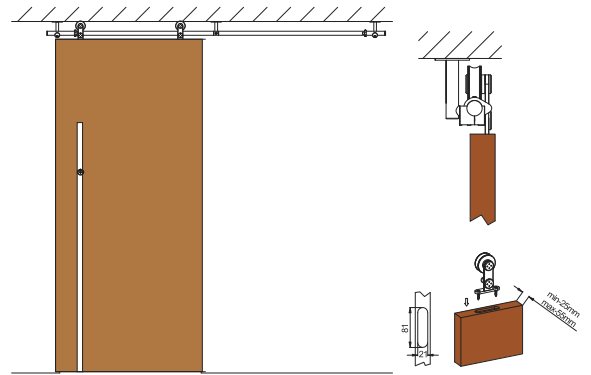
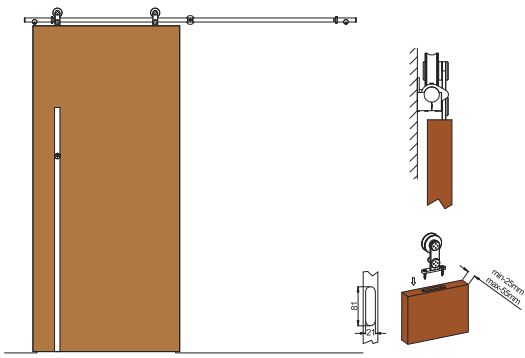

Sistemas de Correr

Slide Door Systems / Systèmes pour Portes Coulissantes /
Sistemas Puertas Correderas / Schiebetürsysteme

SCM-02

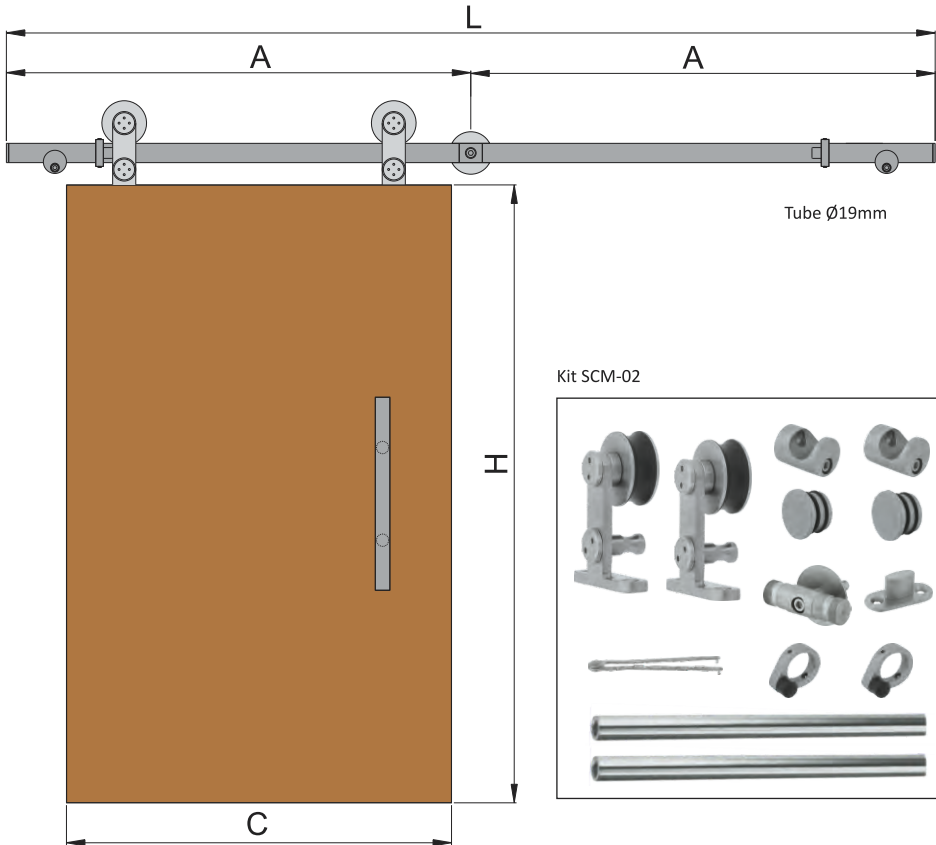

Kit Porta de Uso Intensivo para Tubo Ø19mm
Para Porta de Madeira 25-50mm, 20-40 Kgs

Kit composto por:
2 Carros Superiores para Tubo 19mm Porta de Madeira
2 Batentes de Porta Fixação o Tubo 19mm
2 Suportes Simples Laterais para Tubo 19mm
2 Tampas Laterais para Tubo 19mm
1 Suporte Central de Parede para Tubo 19mm
1 Guia Inferior para Porta de Madeira
2 Tubos 1m Linear Roscado 1 Lado 19mm
1 Chave de Aperto/Usso Medio

Kit Haute Resistance, /Tubo Ø19mm
Pour Porte en Bois, 25-50mm, 20-40 Kgs

Kit Composé de:
2 Chariots Supérieurs /Tubo 19mm Porte en Bois
2 Arrêts de Porte Fixation Tube 19mm
2 Connecteurs Simples Latéraux Tube 19mm
2 Bouchons Latéraux Tube 19mm
1 Support Murial Union Centrale Tube 19mm
1 Guide Inferieur Porte en Bois
2 Tubes de 1m1 Filetage 1 Côté 19mm
1 Clé d'Ajustage

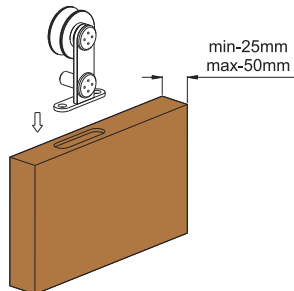

Kit for Heavy Duty for Tube Ø19mm
For Wood Door, 25-50mm, 20-40 Kgs

One set includes:
2 Tracks Rollers, for 19mm tube, Wood Door
2 Rollers Stoppers 19mm
2 Fixing Brackets to wall, Side 19mm
2 Tubes End Plug 19mm
1 Fixing Bracket to wall, Middle 19mm
1 Wood Door Guide
2 Tubes 1 meter long Screw by 1 side - 19mm
1 Fixing Tooling, Light duty

Kit Puerta Alta Resistencia para Tubo Ø19mm
Para Puerta de Madera, 25-50mm, 20-40 Kgs

Un sistema incluye:
2 Roldanas Superiores para Tubo 19mm para Puerta Madera
2 Topes Puerta Fijacion Tubo 19mm
2 Soportes Laterales Pared 19mm
2 Tapons Laterales 19mm
1 Soporte Central Union 19mm
1 Guia Inferior Puerta Madera
2 Tubos 1 metro Lineal Rosca 1 Lado 19mm
1 Llave Ajuste

Sistemas de Correr

Slide Door Systems / Systèmes pour Portes Coulissantes /
Sistemas Puertas Correderas / Schiebetürsysteme

■ Exemplos de Aplicação | Application Examples | Exemples d'application | Ejemplos d' aplicación

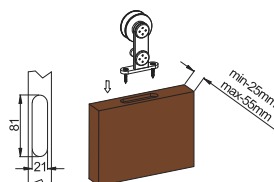
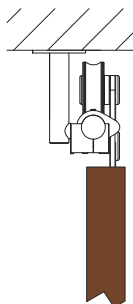
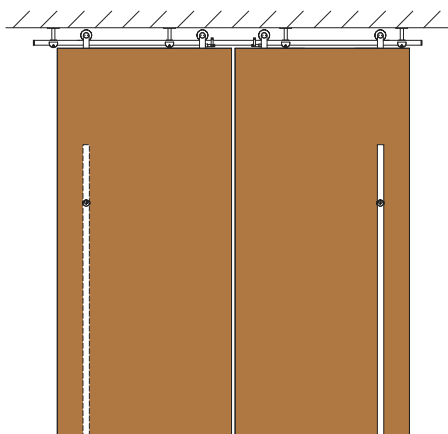
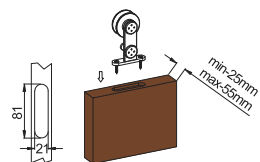
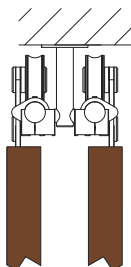
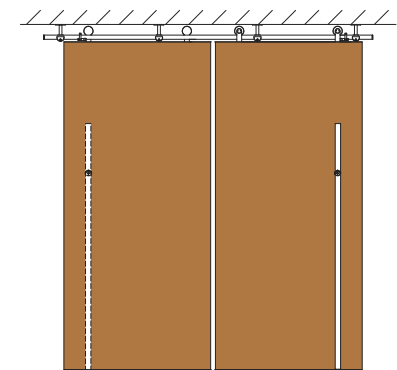

serial C for wood door
standard one set kit use with tube bar include:

- 2pcs track roller for wood door
- 2pcs roller stopper
- 1pc middle bracket
- 2pcs side bracket
- 2pcs tube stainless steel track bar
- 1pc door guide
- 2pc tube end plug

standard one set kit use with solid bar include:

- 2pcs track roller for wood door
- 2pcs roller stopper
- 1pc solid stainless steel track bar
- 1pc door guide

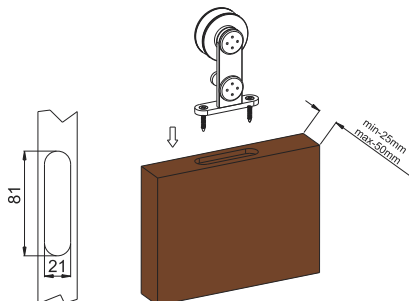

Sistemas de Correr

Slide Door Systems / Systèmes pour Portes Coulissantes /
Sistemas Puertas Correderas / Schiebetürsysteme

CV 01-25



Carro Superior para Tubo 25mm Porta de Vidro
Track Roller, for 25mm Tube, Glass Door
Chariot Supérieur / Tube 25mm Porte en Verre
Roldana Superior para Tubo 25mm para Puerta Cristal

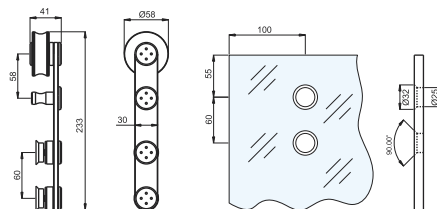

CV 02-19



Carro Superior para Tubo 19mm Porta de Vidro
Track Roller, for 19mm Tube, Glass Door
Chariot Supérieur / Tube 19mm Porte en Verre
Roldana Superior para Tubo 19mm para Puerta Cristal

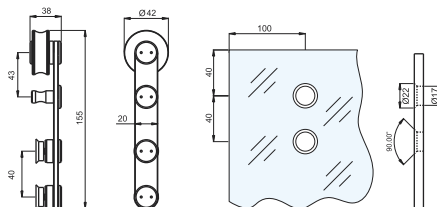

STV 04-25 / STV 04-19

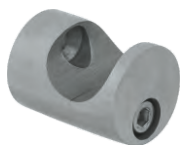

Supporte Simples Lateral
Fixing Bracket to Wall, Side
Support Mural Latéral Simple
Supporte Lateral Pared

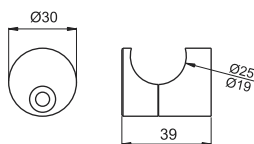

STV 01-25 / STV 01-19



Supporte Central de Pared
Fixing Bracket to Wall, Middle
Support Mural Union Centrale
Supporte Pared Union Centrale

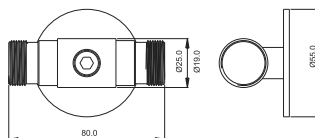

Sistemas de Correr

Slide Door Systems / Systèmes pour Portes Coulissantes /
Sistemas Puertas Correderas / Schiebetürsysteme

STC Simples 19 / STC Simples 25



Suporte Simples União Central de Tecto
Roof Support for Single Door, Middle
Support Plafond Union Centrale
Soporte Techo Sencillo Union Central

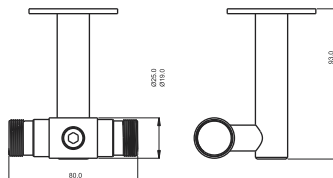

ST Simples 19 / ST Simples 25



Suporte Simples Lateral de Tecto
Roof Support for Single Door, Side
Support Plafond Latéral Simple
Soporte Techo Sencillo Lateral

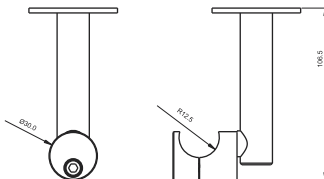

STC Duplo 19 / STC Duplo 25



Suporte Duplo União Central de Tecto
Roof Support for Double Door, Middle
Support Plafond Union Centrale Double
Soporte de Techo Union Central Doble

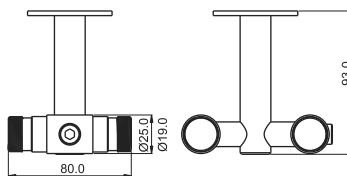

ST Duplo 19 / ST Duplo 25



Suporte Duplo União Lateral de Tecto
Roof Support for Double Door, Side
Support Plafond Union Latérale Double
Soporte de Techo Union Lateral Doble

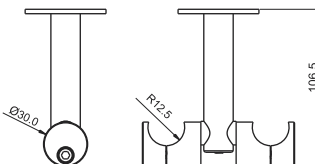

*Acessorio não incluído
Not enclosed accessory
Accessoire non inclus
Accesorio no incluido

Sistemas de Correr

Slide Door Systems / Systèmes pour Portes Coulissantes /
Sistemas Puertas Correderas / Schiebetürsysteme

TIV 01-25 / TIV 01-19



Tampa Lateral para Tubo
Tube End Plug
Bouchon Latéral / Tube
Tapon Lateral para Tubo



S TOPO 01-25 / S TOPO 01-19



Suporte de Topo para Tubo
Tube End Bracket to Wall
Support Mural Latéral / Tube
Suporte Topo Pared para Tubo

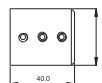
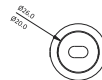

STV 05-25 / STV 05-19



Suporte Simples Lateral Fixação a Vidro
Fixing Bracket to Glass, Side
Support Latéral Fixation Verre
Soporte Lateral Fijacion al Cristal

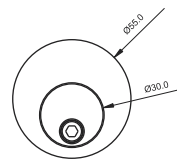
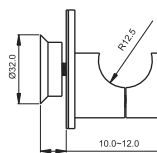

SUCV 06-25 - SUCV 06-19



Suporte Central de Vidro
Fixing Bracket to Glass, Middle
Support p/ Verre Union Centrale
Soporte p/ Cristal Union Central

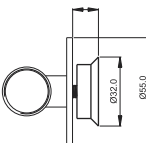
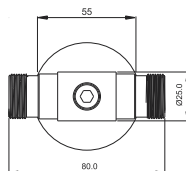

Sistemas de Correr

Slide Door Systems / Systèmes pour Portes Coulissantes /
Sistemas Puertas Correderas / Schiebetürsysteme

BV-02 Ø19mm / BV-02 Ø25mm



Batente de Porta Fixação Tubo
Roller Steeper
Arrêt de Porte Fixation Tube
Tope Puerta Fijacion Tubo

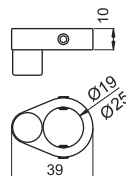

BT 01 R / BT 01 L



Travão Lateral Direito / Esquerdo
Glass Door Holder for Right / Left Side
Frein Latéral Droit / Gauche
Freno Lateral Derecho / Izquierdo

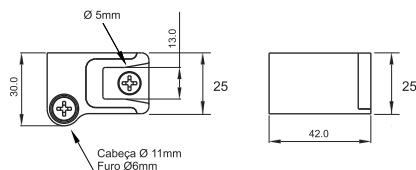

GV 01



Guia Inferior Porta Vidro
Glass Door Guide
Guidé Inferieur Porte en Verre
Guia Inferior Puerta Cristal

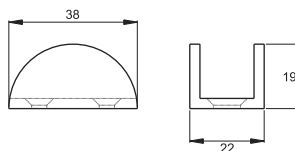

AV 01 | AV 02 | AV 03



Ø1mm, Ø2mm, Ø3mm

Anilha para Suporte Tecto/Parede
Bracket Support Washer
Anneau Mural / Support
Arandela Pared / Techo para Soporte

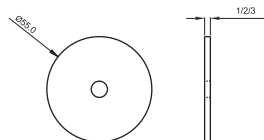

Sistemas de Correr

Slide Door Systems / Systèmes pour Portes Coulissantes /
Sistemas Puertas Correderas / Schiebetürsysteme

CM 01-25



Carro Superior para Tubo 25mm, Porta Madeira
Track Roller, for 25mm Tube, Wood Door
Chariot Supérieur / Tube 25mm, Porte en Bois
Roldana Superior para Tubo 25mm, Puerta Madera

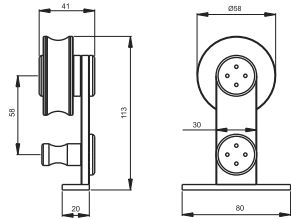

CM 01-19



Carro Superior para Tubo 19 mm, Porta de Madeira
Track Roller, for 19mm Tube, Wood Door
Chariot Supérieur / Tube 19mm, Porte en Bois
Roldana Superior para Tubo 19mm, Puerta Madera

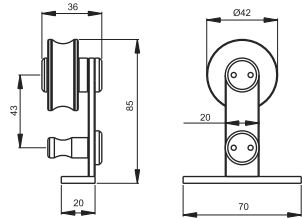

GM 01



Guia Inferior Porta Madeira
Guide for Wood Door
Guide Inférieur / Porte en Bois
Guia Inferior Puerta Madera

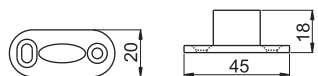

TUB



Disponível | Available | Disponible | Disponible

TUB-01-19 Tubo 1ml Roscado 1 Lado 19mm
TUB-01-25 Tubo 1ml Roscado 1 Lado 25mm
TUB-02R-19 Tubo 1ml Roscado 2 Lados 19mm
TUB-02R-25 Tubo 1ml Roscado 2 Lados 25mm

TUB-01-19 Tube 1ml Screw by 1 side - 19mm
TUB-01-25 Tube 1ml Screw by 1 side - 25mm
TUB-02R-19 Tube 1ml Screw by 2 sides - 19mm
TUB-02R-25 Tube 1ml Screw by 2 sides - 25mm

TUB-01-19 Tube de 1ml Filetage 1 Côté 19mm
TUB-01-25 Tube de 1ml Filetage 1 Côté 25mm
TUB-02R-19 Tube de 1ml Filetage 2 Côtés 19mm
TUB-02R-25 Tube de 1ml Filetage 2 Côtés 25mm

TUB-01-19 Tubo 1ml Rosca 1 Lado 19mm
TUB-01-25 Tubo 1ml Rosca 1 Lado 25mm
TUB-02R-19 Tubo 1ml Rosca 2 Lados 19mm
TUB-02R-25 Tubo 1ml Rosca 2 Lados 25mm

Por Encomenda | By Order | Sur commande | Sobre Pedido

TUB-01-19-3 Tubo 3ml Roscado 1 Lado 19mm
TUB-01-25-3 Tubo 3ml Roscado 1 Lado 25mm
TUB-02R-19-3 Tubo 3ml Roscado 2 Lados 19mm
TUB-02R-25-3 Tubo 3ml Roscado 2 Lados 25mm

TUB-01-19-3 Tube 3ml Screw by 1 side - 19mm
TUB-01-25-3 Tube 3ml Screw by 1 side - 25mm
TUB-02R-19-3 Tube 3ml Screw by 2 sides - 19mm
TUB-02R-25-3 Tube 3ml Screw by 2 sides - 25mm

TUB-01-19-3 Tube de 3ml Filetage 1 Côté 19mm
TUB-01-25-3 Tube de 3ml Filetage 1 Côté 25mm
TUB-02R-19-3 Tube de 3ml Filetage 2 Côtés 19mm
TUB-02R-25-3 Tube de 3ml Filetage 2 Côtés 25mm

TUB-01-19-3 Tubo 3ml Rosca 1 Lado 19mm
TUB-01-25-3 Tubo 3ml Rosca 1 Lado 25mm
TUB-02R-19-3 Tubo 3ml Rosca 2 Lados 19mm
TUB-02R-25-3 Tubo 3ml Rosca 2 Lados 25mm

Sistemas de Correr

Slide Door Systems / Systèmes pour Portes Coulissantes /

Sistemas Puertas Correderas / Schiebetürsysteme

PERFIL PUXADOR 1

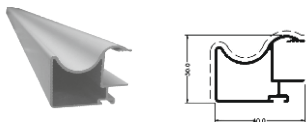

PERFIL PUXADOR 2



papel melamina
melamine paper
mélamine papier
papel melamina

folheado a madeira
veneer wood
placage de bois
hoja de madera

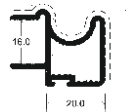

PERFIL REMATE

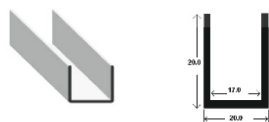

PERFIL INFERIOR

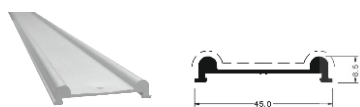

PERFIL SUPERIOR

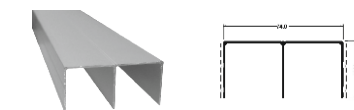

PERFIL H



CARRO SUPERIOR

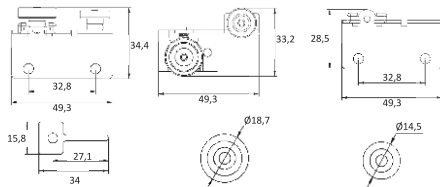
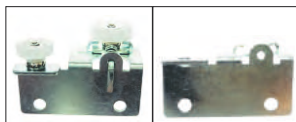

CARRO INFERIOR T



CARRO INFERIOR U

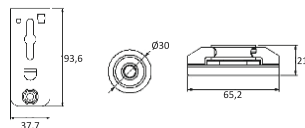
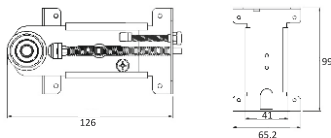
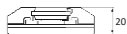

CARRO INFERIOR No. 2

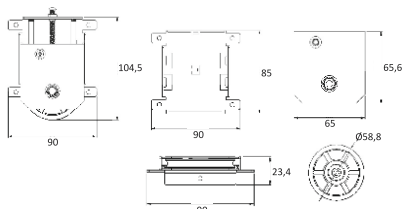
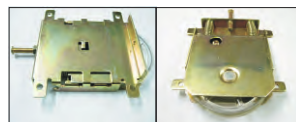

Sistemas de Correr

Slide Door Systems / Systèmes pour Portes Coulissantes /
Sistemas Puertas Correderas / Schiebetürsysteme

3100

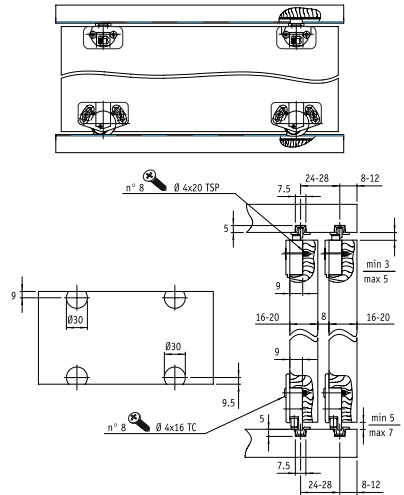
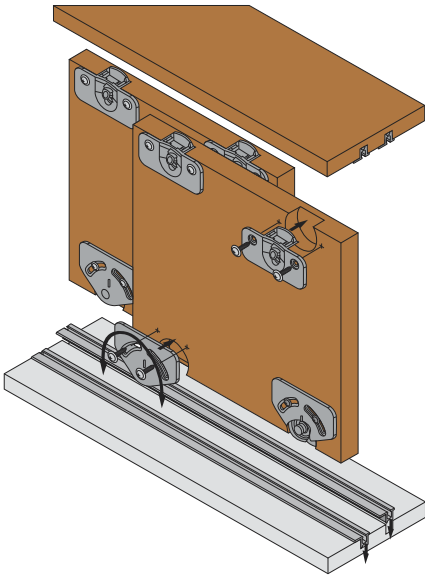

CALHA 3100

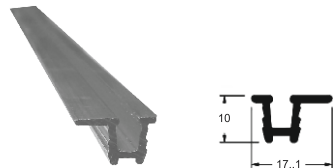

KIT 3100 - 25Kgs

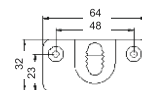
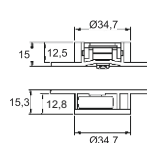
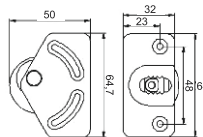
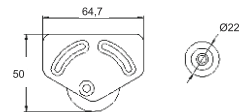

Sistemas de Correr

Slide Door Systems / Systèmes pour Portes Coulissantes /
Sistemas Puertas Correderas / Schiebetürsysteme

■ 3200

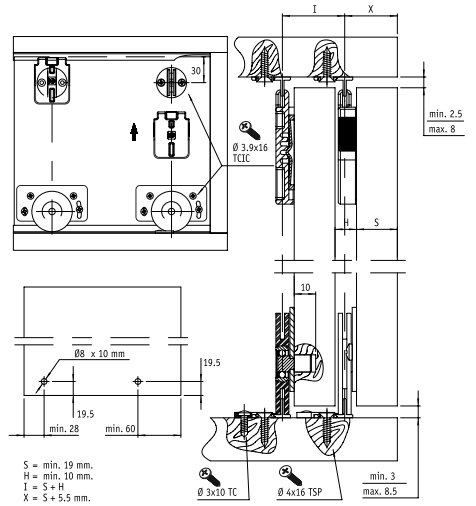
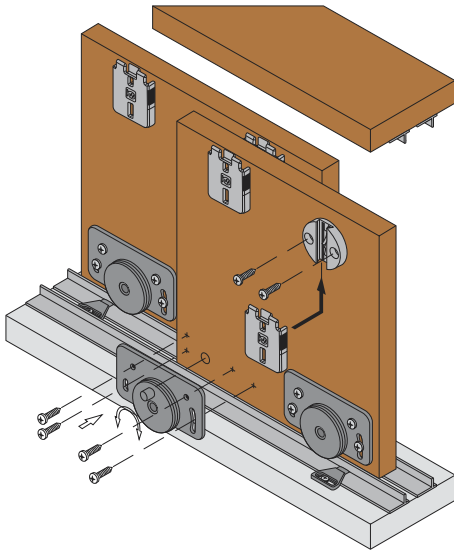

■ CALHA 3200

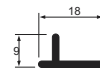

■ KIT 3200 - 25Kgs

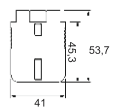
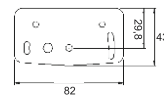
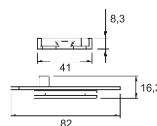
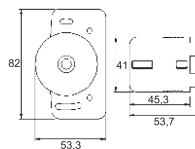
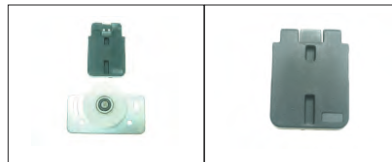

Sistemas de Correr

Slide Door Systems / Systèmes pour Portes Coulissantes /
Sistemas Puertas Correderas / Schiebetürsysteme

■ 4000

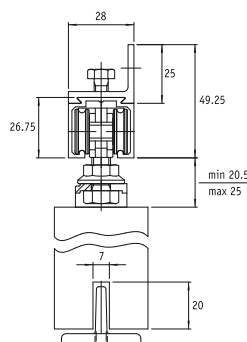
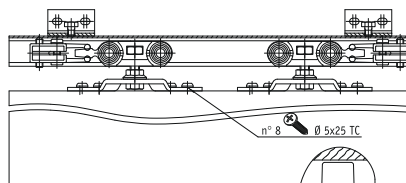
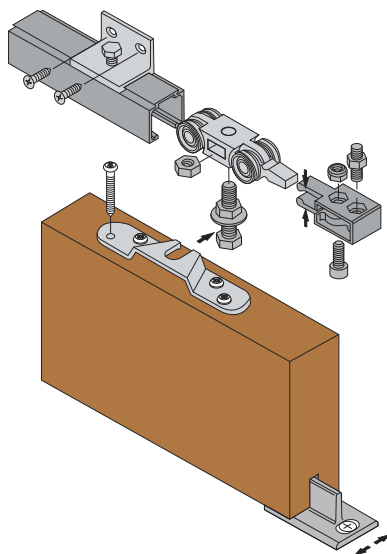

■ CALHA 4000 40Kg

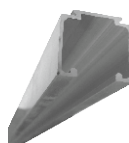

■ KIT 4000 - 40Kgs

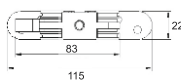
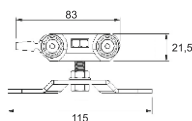
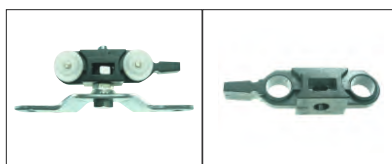

Sistemas de Correr

Slide Door Systems / Systèmes pour Portes Coulissantes /
Sistemas Puertas Correderas / Schiebetürsysteme

■ 4500

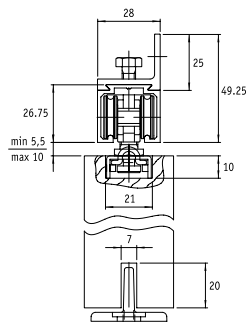
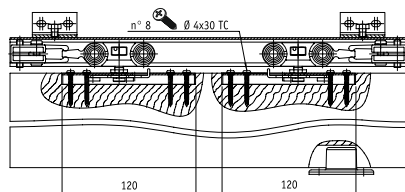
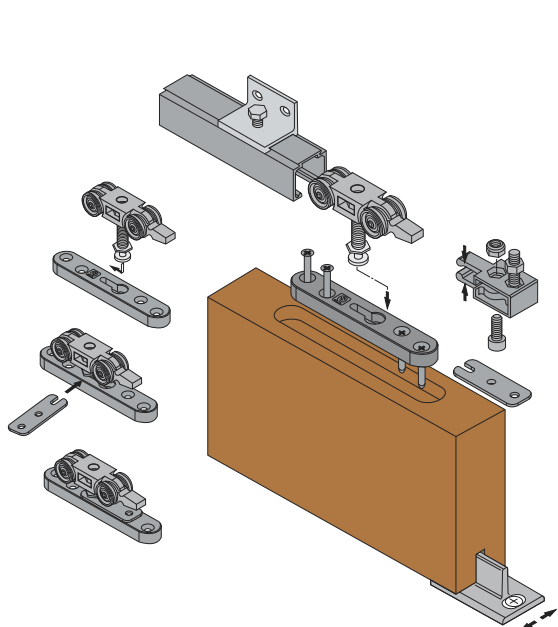

■ CALHA 4000 40Kg

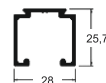
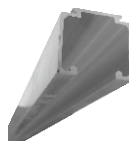

■ KIT 4500 - 40Kgs

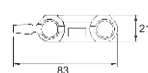
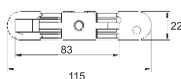
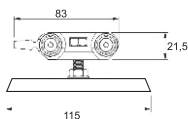
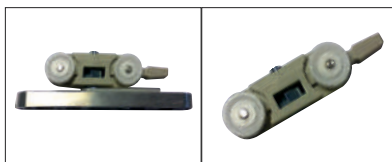

Sistemas de Correr

Slide Door Systems / Systèmes pour Portes Coulissantes /
Sistemas Puertas Correderas / Schiebetürsysteme

5000

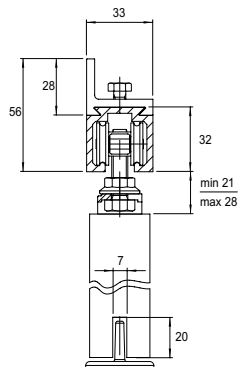
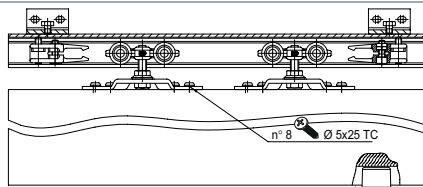
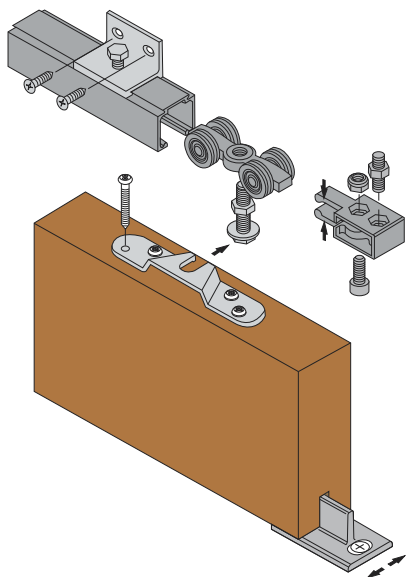

■ CALHA 5000 80/120Kg

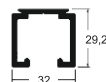
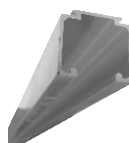

■ KIT 5000 - 80Kgs/120Kgs

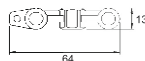
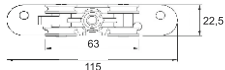
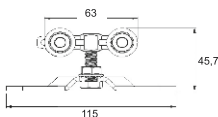
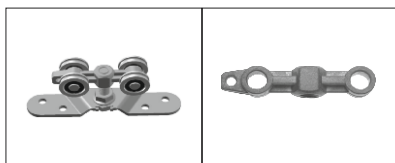

Sistemas de Correr

Slide Door Systems / Systèmes pour Portes Coulissantes /
Sistemas Puertas Correderas / Schiebetürsysteme

■ 4700

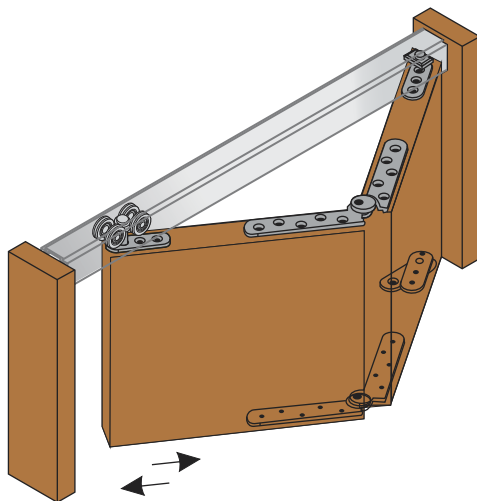
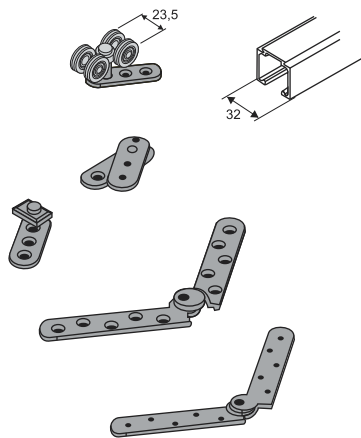

■ CALHA 5000 80/120Kg

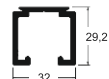
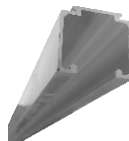
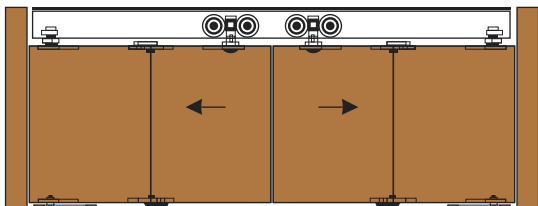

■ GUIA NYLON

■ KIT 4700 - 60Kgs



Sistemas de Correr

Slide Door Systems / Systèmes pour Portes Coulissantes /
Sistemas Puertas Correderas / Schiebetürsysteme

4940

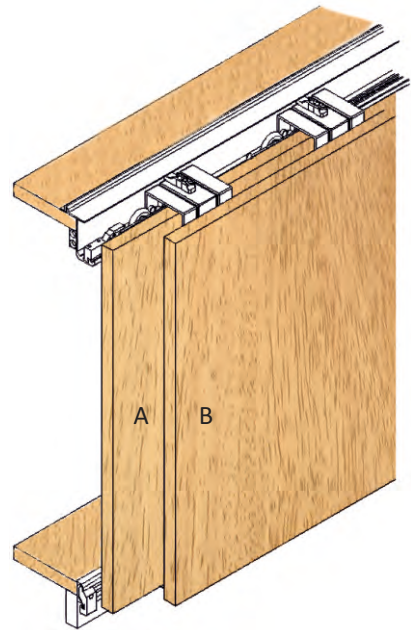
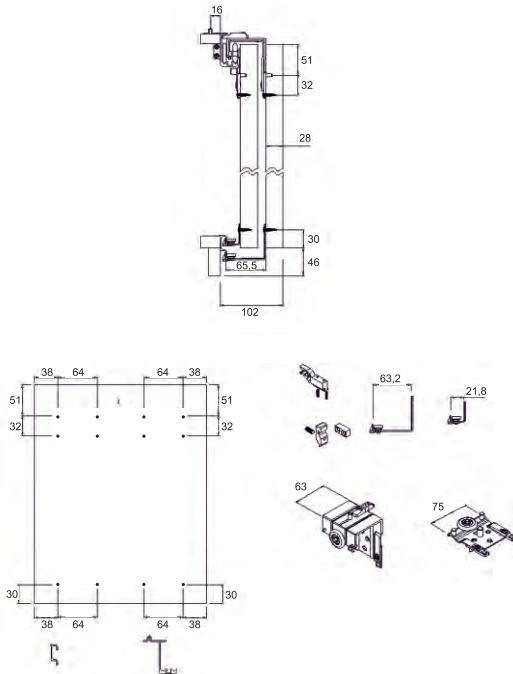

KIT 4940 - 60Kgs

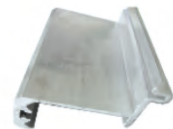
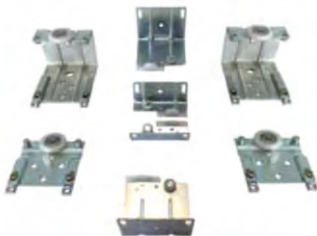

PS4900 - Calha Superior

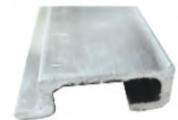

PI4900 - Calha Superior

Sistemas de Correr

Slide Door Systems / Systèmes pour Portes Coulissantes /
Sistemas Puertas Correderas / Schiebetürsysteme

5000 VD09

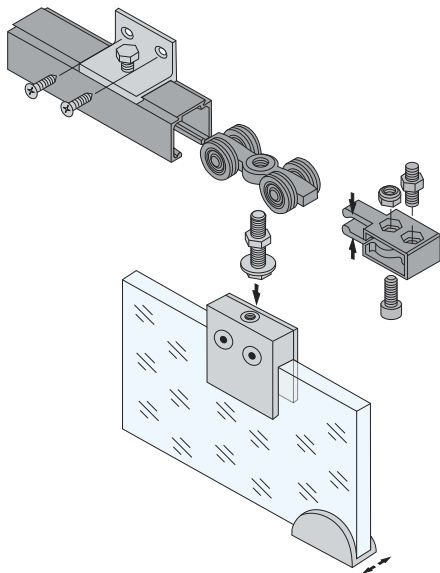

Kit 20 Kg

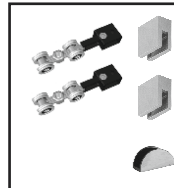

Kit composto por:
One set includes:
Kit composé de:
Un sistema incluye:
2 VD 09
1 Kit 5000
1 GV 01

CALHA 5000 80/120Kg

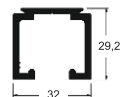
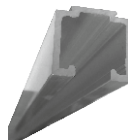

5000 VD08

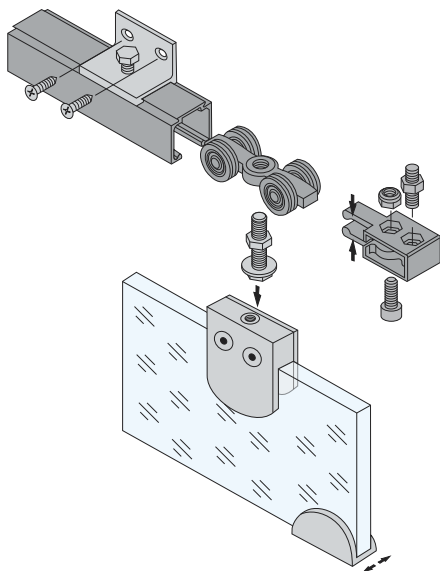

Kit 20 Kg

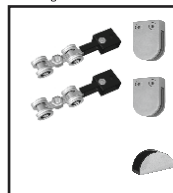

Kit composto por:
One set includes:
Kit composé de:
Un sistema incluye:
2 VD 08
1 Kit 5000
1 GV 01

CALHA 5000 80/120Kg

